



HARDINGE
TALENT® Series 42/51
Multi-Tasking CNC
Turning Centers



www.hardinge.com



Take your Hardinge collet-ready spindle lathe to the limit using flexible workholding options

Hardinge is unique as a machine tool builder — we manufacture our own workholding products. Precision and accuracy is yours when you use Hardinge perfectly-mated workholding products.

Collets

Hardinge hardened and ground collets are inspected and measured in a Hardinge SUPER-PRECISION® spindle. Collets are available in fractional round, hex and square sizes and round metric, as well as round serrated fractional and metric sizes. Use adjustable, machinable collet stops for accurate part positioning.



Emergency Collets

Emergency collets have a soft face with a pilot hole for customer drilling, boring and stepping out to the exact size required. An optional extended nose permits deeper counterbores when required and tool clearance for extended work.

FlexC™ Quick-Change Vulcanized Collet Systems

Interchangeable quick-change vulcanized collet heads have a working range of $\pm .020$ " (0.5mm) to accept bar stock variation. Collets change in seconds, while accuracy is maintained at $.0004$ " (.010mm).



Style "S" Master Collets and Pads

Pads can be changed much quicker than solid collets can. Pads cost less and use less storage space when compared to a standard solid collet. Choose from hardened and ground, semi-hard and emergency pads. Styles S16, S20 and S26 require a collet closer.

3-Jaw Power Chucks

Hardinge power chucks are lever operated, counter-centrifugal and dynamically balanced. Quick-change chucks are also available.



Sure-Grip® Expanding Collet Systems

The Hardinge Sure-Grip expanding collet provides high-precision, internal gripping solutions with true parallel gripping. Collet-style and spindle-mount styles are available, depending on the machine model.



Master Expanding Collets are a lower-cost alternative to Sure-Grip Expanding Collet Systems and include a dead-length feature.

Step Chucks and Closers

Step Chucks and closers are used to accurately hold larger diameter parts.



Force-Limiting Step Chuck

The Hardinge force-limiting step chuck has built-in force control to safely grip thin-wall parts. Maintain inside and outside concentricity in a fail-safe process while eliminating the nuisance of manually tweaking the draw bar.



Dead-Length® Systems

Maintain part-length control by using Hardinge dead-length systems. Choose from dead-length collet assemblies, thru-hole collets, step chucks and spider-stop step chucks. 16C to #22 B&S adapter shown on A2-5 sub-spindle.



The Hardinge Advantage

The spindle design is both collet and jaw chuck-ready and does not require a spindle adaptor. Hardinge I6C collets seat directly into the spindle closest to the bearings, so that spindle accuracy is transferred directly to the workpiece. Take advantage of using maximum spindle speeds and feeds, utilizing the maximum working envelope with quick job to job changeover from bar work to chucking.

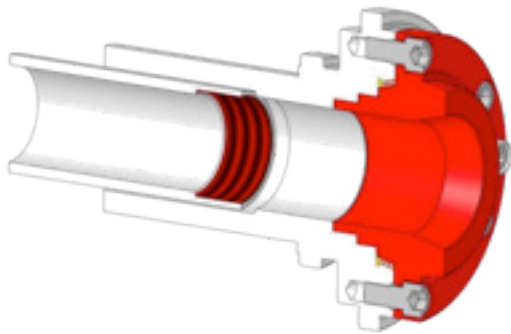

- Hardinge C-Style
- Hardinge Step Chucks & Closers
- Hardinge Sure Grip Expansion Systems
- Hardinge Sure Grip Jaw Chucks

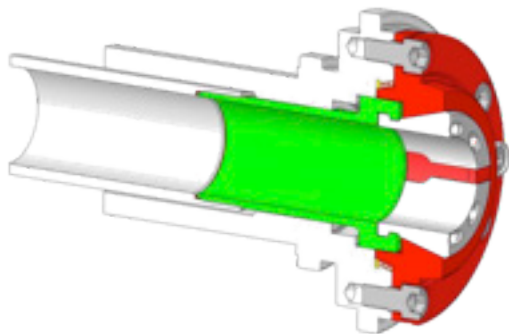

- Hardinge Flex C

Hardinge offers you total flexibility with its CFS spindle nose configuration, one spindle will accept all types of collet systems allowing for maximum working envelope to be realized. Component parts remain close to the spindle bearings allowing for higher part to part accuracy, better surface finish with longer tool life capability. Fast collet to collet or chuck with proven technology throughout its design

Two main spindle configurations to choose from:

- Hardinge A2-5 I6C Collet Ready with 42mm thru-spindle capacity, (includes a drawbar adaptor to suit - 150mm (6 inch) 3 Jaw Chuck with 42mm thru-spindle capacity)
- Hardinge CFS* Global work holding spindle adaptation system with 51mm thru-spindle capacity; (includes a A2-6 20C collet adaptor to suit 200mm (8" 3-jaw chuck with 51mm thru-spindle capacity)

* Available on TALENT 51 only



CONFIGURATIONS & FEATURES

The Hardinge TALENT® Series machines offer an exceptional combination of features for accuracy, flexibility and durability in a compact design.

The unique collet-ready main and sub-spindle design will increase part accuracy and improve surface finish. The TALENT® Series offers two separate base structures which feature a robust one-piece cast iron base, heavy duty roller linear guideways and ballscrews, with many standard value-added features – through-tool and headwall air / coolant for both main and sub-spindles, foot switches, chip conveyor interface, barfeed interface, air hose with air gun. The machine will feature the Fanuc OiTF control which include many value added features.

Choose from any of the productivity options below and you'll have a truly versatile machine tool with a level of quality you would expect with any Hardinge Product.

- Servo-Driven Tailstock
- Live Tooling
- Y-Axis
- Sub-Spindle

The TALENT is available in the following configurations:



TALENT 42 Short Bed

– MY (Milling / Y Axis)

TALENT 42 Standard Bed

– MYT (Milling / Y Axis / Tailstock)

– MSY (Milling / Sub Spindle / Y Axis)



Standard Features

- Fanuc 0iTF (10.4") color LCD display
- Manual Guide-i
- Central Grease Lubrication (Manual)
- A2-5 16C Collet Ready Spindle (TALENT 42)
- A2-6 20C CFS Collet Ready Spindle (TALENT 51)
- BMT 45 Live Tooling 12 Station with ½ Index Capability
- Foot Switch Main Spindle Chuck/Collet
 - Open/Close
- Foot Switch Sub-Spindle Chuck/Collet
 - Open/Close
- Three Color Indicator Light
- Headwall Coolant (Main & Sub-Spindle)
- Bar Feed Interface
- Chip Conveyor Interface

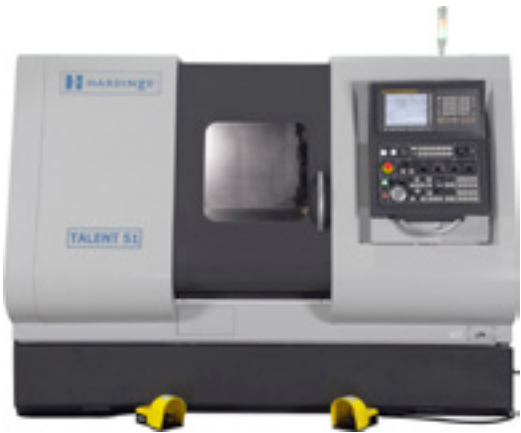

TALENT 51 Short Bed

- MY (Milling / Y Axis)

TALENT 51 Standard Bed

- MYT (Milling / Y Axis / Tailstock)
- MSY (Milling / Sub Spindle / Y Axis)

Available Options



Tool Touch Probe

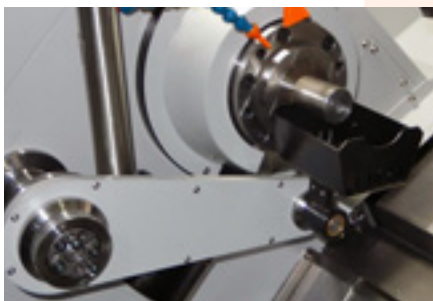

Parts Catcher

- Central Grease Lubrication (Auto Pump Lubrication) factory order only
- Coolant & Air Management Systems
 - Coolant through Main & Sub-Spindle
 - Med. Pressure Coolant with max. 300 PSI
 - Mist Collector Unit
 - Headwall Airblast Main & Sub-Spindle
- Power Transformer
- Measurement Systems
 - Tool Touch Probe – Renishaw
 - Component Part Probe – Renishaw
- Chip Management Systems
 - Right Side Hinge Type Chip Conveyor
 - Right Side Scraper Type Chip Conveyor
- Component Part Handling
 - Parts Catcher - Main Spindle to Trap-Door
 - Parts Catcher – Main Spindle with Parts Conveyor
 - Bar Feed – Short Magazine, Max Bar Length 1.5m (with BSU)
 - Bar Feed – Full Length Magazine, Max Bar Length 4.2m
- Sub-Spindle Part Detection
- Sub-Spindle Part Ejection
- Live Center, #4 Morse taper for tailstock
- 8 Sets of Spare M Codes
- Part removal system - Part catcher with conveyor
- BMT 45 - 16 stations Live tooling turret
- BMT 45 Statics Tooling Package

TALENT 5 I MSY Work Envelope

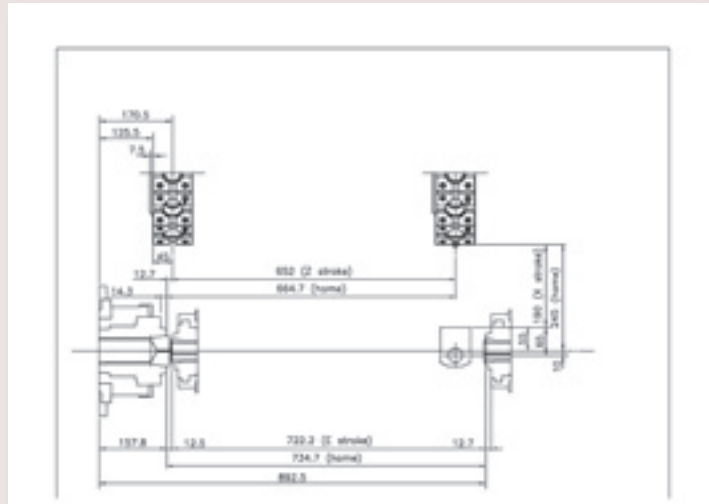

Y-axis

Y-axis capability is a huge productivity enhancement on a turn/mill machine tool. To get Y-axis motion, an extra set of ways is used to move the live tool across the face of the spindle. By adding a third linear axis to the turning center turret it enables rotary cutters to machine across the spindle center line thus greatly expanding the milling capabilities of the machine.

Y-Axis Slide

Wedge Type Construction
Y-Axis Travel: +/- 1.65" (42mm)

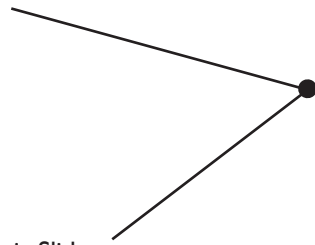

BMT 45 Bi-Directional Turret

- DIN 1809 Specification
- 0.7" (20mm) Square Shank Tooling
- 1.25" (32mm) Round Shank Tooling
 - Standard - 12 Station with half-index
 - Optional - 16 Station
 - Max. Coolant Pressure = 300 psi
- Higher pressure requires optional turret spec.
- Factory Options:
 - 280 psi Coolant Thru Tool
 - Air Blast Thru Tool

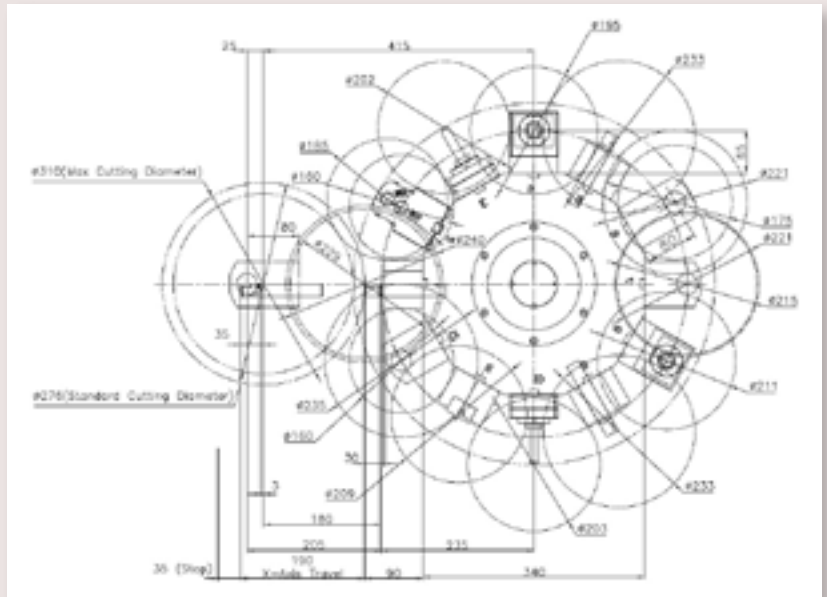

Sub-Spindle

The belt driven sub spindle features a maximum power rating 11kw (15HP) motor with a speed range of up to 6,000RPM. The A2-5/16C Collet-ready spindle allows for the use of a complete assortment of spindle tooling including collets and jaw chucks. It also includes a pneumatic collet-closer and rigid tapping is standard.

Tailstock

- Taper : MT#4
- Max Thrust: 3470N (780 lbs.)
- Tailstock is servo driven on heavy duty linear roller guideways and ballscrew (E-Axis)
- The system will accommodate a #4 Morse taper Revolving Center
- This "no quill" style tailstock is fully programmable allowing you to set the required tailstock force, rapid advance/retract rate, and position between machining cycles
- Multiple positioning is possible to allow for multiple bar feed "out" applications



POWER & TORQUE CHARTS

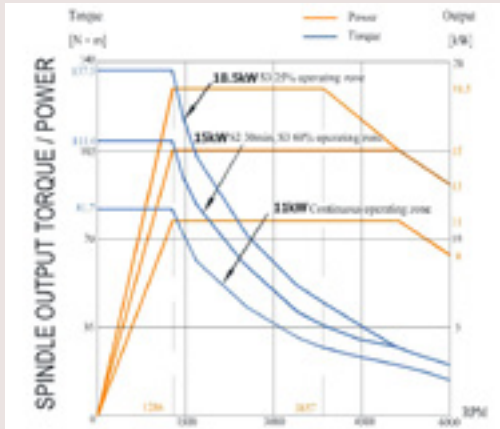

TALENT 42

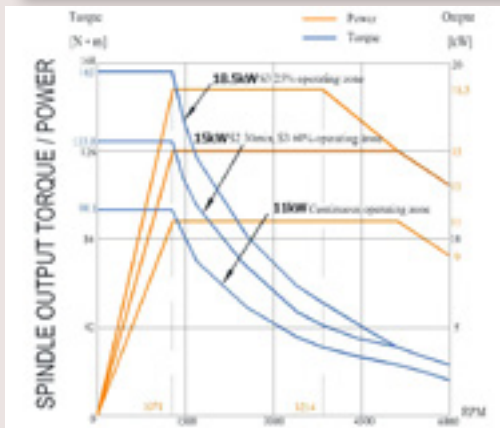

TALENT 51

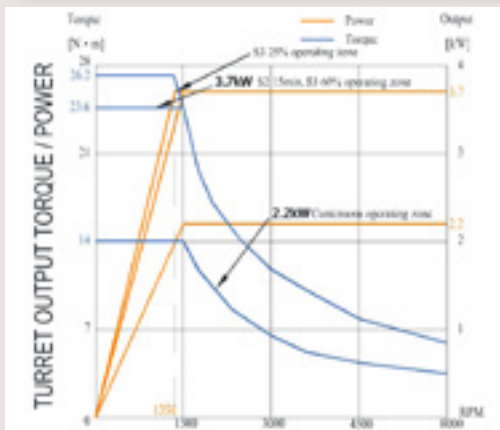

TALENT 42 & TALENT 51

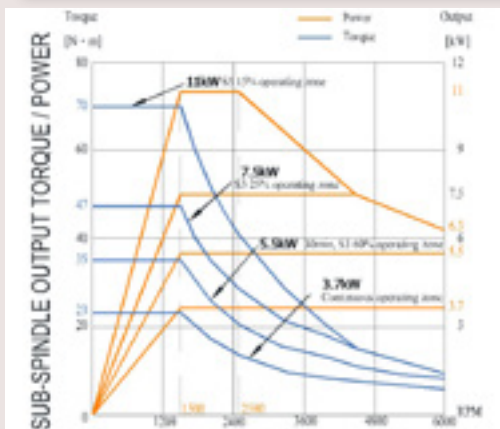

TALENT 42 & TALENT 51

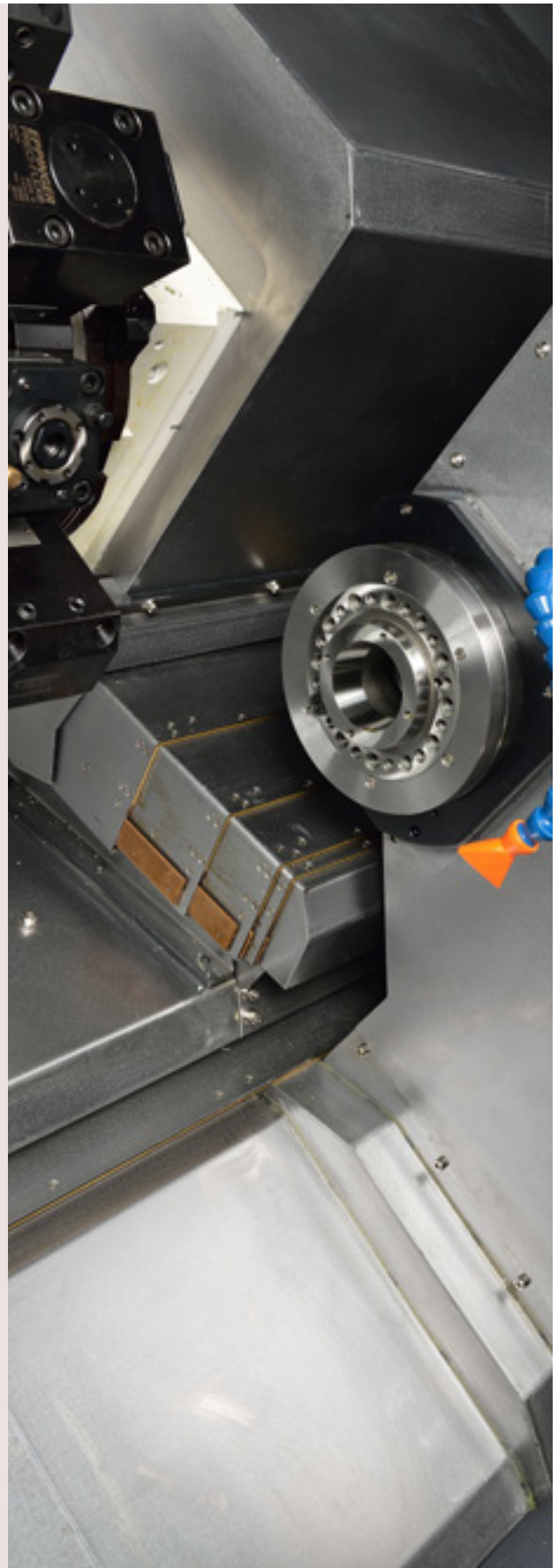

FANUC

Fanuc Control*

- 10.4" color LCD display screen aids in viewing the various programming and function pages
- The operators panel is custom-designed to be user friendly
- Fanuc Oi-TF control on robust pendent mount
- The control pendent conveniently swings for better user access and can be moved out of the work zone for robot type applications where interlocking gate access is required
- Full MSY capability
- Manual Guide-i (MG-i) programming is standard
- Packed with standard features



Standard Features

General

- Pendent-mounted Full Control
- 10.4" LCD Display
- Graphic Display
- Embedded Ethernet
- RS-232C Communication Ports
- Program Resolution .0001" (.001mm)
- Tool Offset Capability .0001" (.001mm)
- Tool Offsets with Geometry/Wear (99)
- Absolute Encoders
- Inch/Metric Selection by G-Code
- Part Program Storage 512KB

Programming Functions

- Absolute/Incremental Programming
- Additional Custom Macro Variables
- Alarm Display
- Auto Acceleration/Deceleration
- Auto Coordinate System Setting
- Background Editing
- Canned Cycles (Drilling)
- Chamfer/Corner Rounding
- Circular Interpolation by R Programming
- Constant Surface Speed Programming
- Continuous Thread Cutting
- Coordinate System Setting (G50)
- Custom Macro B

Programming Functions cont'd

- Decimal Point Programming
- Diameter/Radius Programming
- Direct Drawing Dimension Programming
- Display Position, Program, Alarm, History
- Extended Part Program Edit (copy/replace)
- External Workpiece Number Search
- Hardinge Safe Start Format
- Helical Interpolation (for Y-Axis)
 - o Helical Interpolation (for Non Y-Axis)
- Help Screen
- Input of Offset Values by (G10)
- Interpolation (Linear/Circular)
- MPG Manual Pulse Generator
- Manual Guide i with full color display
- Multiple Repetitive Cycles I (Turning)
- Multiple Repetitive Cycles II (Pocketing)
- Multi Spindle Control
- Program Number Search
- Programmable Parameter Input
- Reference Point Return
- Registered Part Program Storage (125)
- Rigid Tapping
- Spindle Orient Main & Sub (Std. on Live Tooling Models)
- Spindle Synchronization (Main & Sub)
- Sequence Number Search

Programming Functions cont'd

- Single Block Operation
- Skip Function G31
- Stored Stroke Check 1, 2 & 3
- Sub Program Call (10 fold nested)
- Thread Cutting Retract
- Thread Cutting
- Tool Life Management
- Tool Nose Radius Compensation (Geometry/Wear)
- Variable Lead Thread Cutting
- Workpiece Coordinate System (G52-G59)

Miscellaneous

- Actual Cutting Speed and T-Code Display
 - Dual Check Safety
 - English
 - French/German/Italian/Spanish Language
 - Chinese in Fanuc menus only
 - Flash Card Capability PCMICA (up to 1 GB)
 - Full Keyboard
 - Ladder Diagram Display
 - Polar Coordinate Interpolation
 - Cylindrical Interpolation
- Standard
o Option

*North American standard. Siemens available

Floor Plan

TALENT® 42/51 Short Bed



TALENT® 42/51 Standard Bed

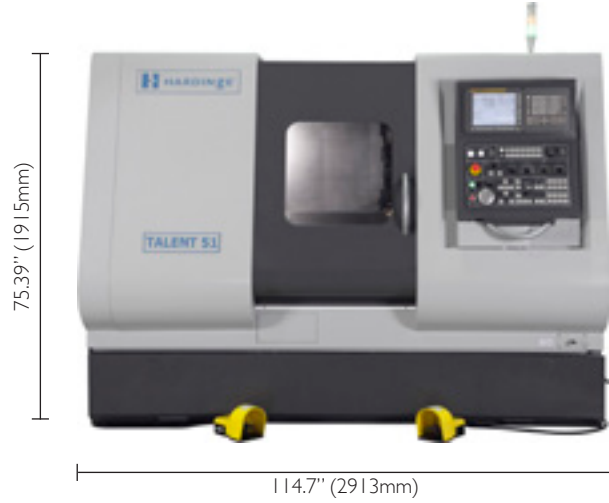

Floor Plan with Optional Chip Conveyor

TALENT® 42/51 Short Bed



TALENT® 42/51 Standard Bed



Main Spindle	TALENT® 42 MY		MYT,MSY	
	Short Bed		Standard Bed	
	TALENT® 51 MY		MYT,MSY	
	Short Bed		Standard Bed	
Collet Ready Spindle Config - ANSI	A2-5 / 16C		CFS/A2-6 / 20C	
Draw Tube Type	Hydraulic		Hydraulic	
Through Draw Tube Capacity	1.65" (42mm)		2" (51mm)	
Gripping Capacity with Step Chuck & Closer	5.9" (150mm)		8" (203mm)	
Maximum Swing Over Way Cover	21.65" (550mm)		21.65" (550mm)	
Machining Diameter - Max.	12.2" (310mm)		12.2" (310mm)	
Turning Length - Max (without chuck)	13.16" (334.5mm)	23.4" (594.5mm)	13.16" (334.5mm)	23.4" (594.5mm)
Turning Length - Max (with chuck)	8.61" (218.9mm)	18.85" (478.9mm)	8.12" (206.3mm)	18.35" (466.2mm)
Max. Speed (1 rpm Steps)	6000 rpm		5000 rpm	
Base Speed	1286 rpm		1071 rpm	
Continuous Power Rating	14.75HP (11 kW)		14.75HP (11 kW)	
Maximum Power Rating	24.80HP (18.5 kW)		24.80HP (18.5 kW)	
Continuous Torque Rating	81.6 Nm (60.24 ft.lb.)		98.1 Nm (72.31 ft.lb.)	
Maximum Torque Rating	137.3 Nm (101.32 ft.lb.)		165 Nm (121.7 ft.lb.)	
Sub-Spindle				
Collet Ready Spindle Configuration	A2-5 / 16C		A2-5 / 16C	
Draw Tube Type	Hydraulic		Hydraulic	
Through Draw Tube Capacity	1.65" (42 mm)		1.65" (42 mm)	
Gripping Capacity with Step Chuck & Closer	5.9" (150 mm)		5.9" (150 mm)	
Max. Speed (1 rpm Steps)	6000 rpm		6000 rpm	
Base Speed	1500 rpm		1500 rpm	
Continuous Power Rating	5HP (3.7 Kw)		5HP (3.7 Kw)	
Maximum Power Rating	15HP (11 Kw)		15HP (11 Kw)	
Continuous Torque Rating	23.5 Nm (17.3 ft.lb.)		23.5 Nm (17.3 ft.lb.)	
Maximum Torque Rating	70 Nm (51.62 ft.lb.)		70 Nm (51.62 ft.lb.)	
Turret Configurations				
12 Station with ½ Index Capability	BMT 45		BMT 45	
Drive Configuration (opt. 16 Station)	DIN 1809		DIN 1809	
12 Station	VDI 30		VDI 30	
Drive Configuration	DIN 5480		DIN 5480	
Live Tooling Drive System				
Max. Speed (1 rpm Steps)	5000 rpm		5000 rpm	
Maximum Power Rating	5HP (3.7 Kw)		5HP (3.7 Kw)	
Maximum Torque Rating	26.1 Nm (19.3 ft.lb.)		26.1 Nm (19.3 ft.lb.)	
Travels and Feed Rates				
X Axis Travel Max - Live Tooling (BMT / VDI)	7.48" (190mm)		7.48" (190mm)	
Z Axis Travel Max	15.43" (392mm)	25.67" (652mm)	15.43" (392mm)	25.67" (652mm)
Y Axis Travel Max	1.65" (+/- 42mm)		1.65" (+/- 42mm)	
X and Z Axis Rapid Traverse Rates	30 m/min (1181 ipm)		30 m/min (1181 ipm)	
Y Axis Rapid Traverse Rates	10 m/min (394 ipm)		10 m/min (394 ipm)	
Machine Accuracy				
Evaluation Standard	ISO 230-2		ISO 230-2	
Repeatability - X & Z Axes (ISO)	0.000197" (0.005mm)		0.000197" (0.005mm)	
Machine Dimensions				
Length	101.1" (2567mm)	114.7" (2913mm)	101.1" (2567mm)	114.7" (2913mm)
Depth	71.42" (1814mm)		71.42" (1814mm)	
Height	76.1" (1932mm)		76.1" (1932mm)	
Weight	10,802 lbs (4900 kg)	12,786lbs (5800 kg)	10,802 lbs (4900 kg)	12,786lbs (5800 kg)

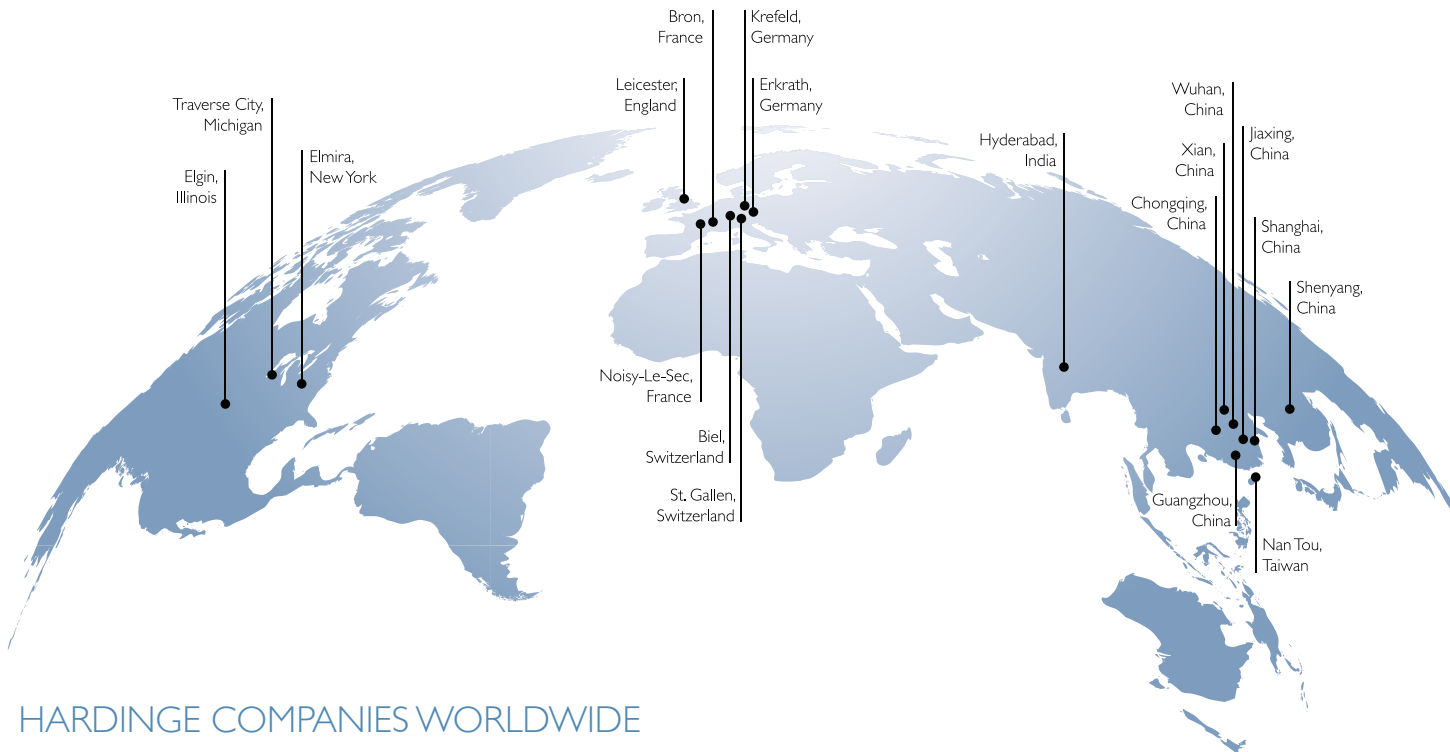

HARDINGE COMPANIES WORLDWIDE

Over the years, The Hardinge Group™ steadily diversified both its product offerings and operations. Today, the company has grown into a globally diversified player with manufacturing operations in North America, Europe and Asia. In addition to designing and building turning centers, and collets, Hardinge is a world leader in grinding solutions with the addition of the Kellenberger, Jones & Shipman, Hauser, Tschudin, Usach and Voumard brands to the Hardinge family. The company also designs and manufactures Bridgeport machining centers and other industrial products for a wide range of material cutting, turnkey automation and workholding needs.

Expect more from your Hardinge products. Choose Hardinge precision and reliability for increased productivity and value!

Call us today, we've got your answer.

North America

Hardinge Inc.
 General Information: 607.734.2281
 Sales Fax: 607.734.8819
 Workholding Fax: 607.734.3886
 Service: 800.424.2440
www.hardinge.com

Canada

Canadian Hardinge Machine Tools Ltd.
 Tel: 800.468.5946
 Fax: 607.734.8819

China

Hardinge Machine (Shanghai) Co. Ltd.
 Hardinge China Limited
 Tel: 0086 21 38108686
 Fax: 0086 21 38108681

Hardinge Precision Machinery (Jiaxing) Co., Ltd.
 Economic and Technology Development Zone
 Tel: 0573-82601088
 Fax: 0573-82601988

Germany

Hardinge GmbH
 Tel: (49) 2151 496490

Fax: (49) 2151 4964999

Taiwan

Hardinge Machine Tools B.V.
 Tel: 886 49 2260536
 Fax: 886 49 2252203
cs@hardinge.com.tw

Switzerland

L. Kellenberger & Co. AG
 Tel: +41 (0) 71 242 91 11
 Fax: +41 (0) 71 242 92 22
info@kellenberger.com
www.kellenberger.com

L. Kellenberger & Co. AG
 Tel: +41 (0)32 344 11 52
 Fax: +41 (0)32 341 13 93
info@kellenberger.com
www.kellenberger.com

United Kingdom

Jones & Shipman Hardinge
 Tel: +44 (0) 116 2013000
 Fax: +44 (0) 116 2013002
info@jonesshipman.com
www.jonesshipman.com



All specifications subject to change without notice.
 All marks indicated by ® and ™ are trademarks of their respective owners. #151 ID • Litho in USA
 © Hardinge Inc. 2017 • January 2017