

# Cincom

## L32

Sliding Headstock Type CNC Automatic Lathe

# CITIZEN



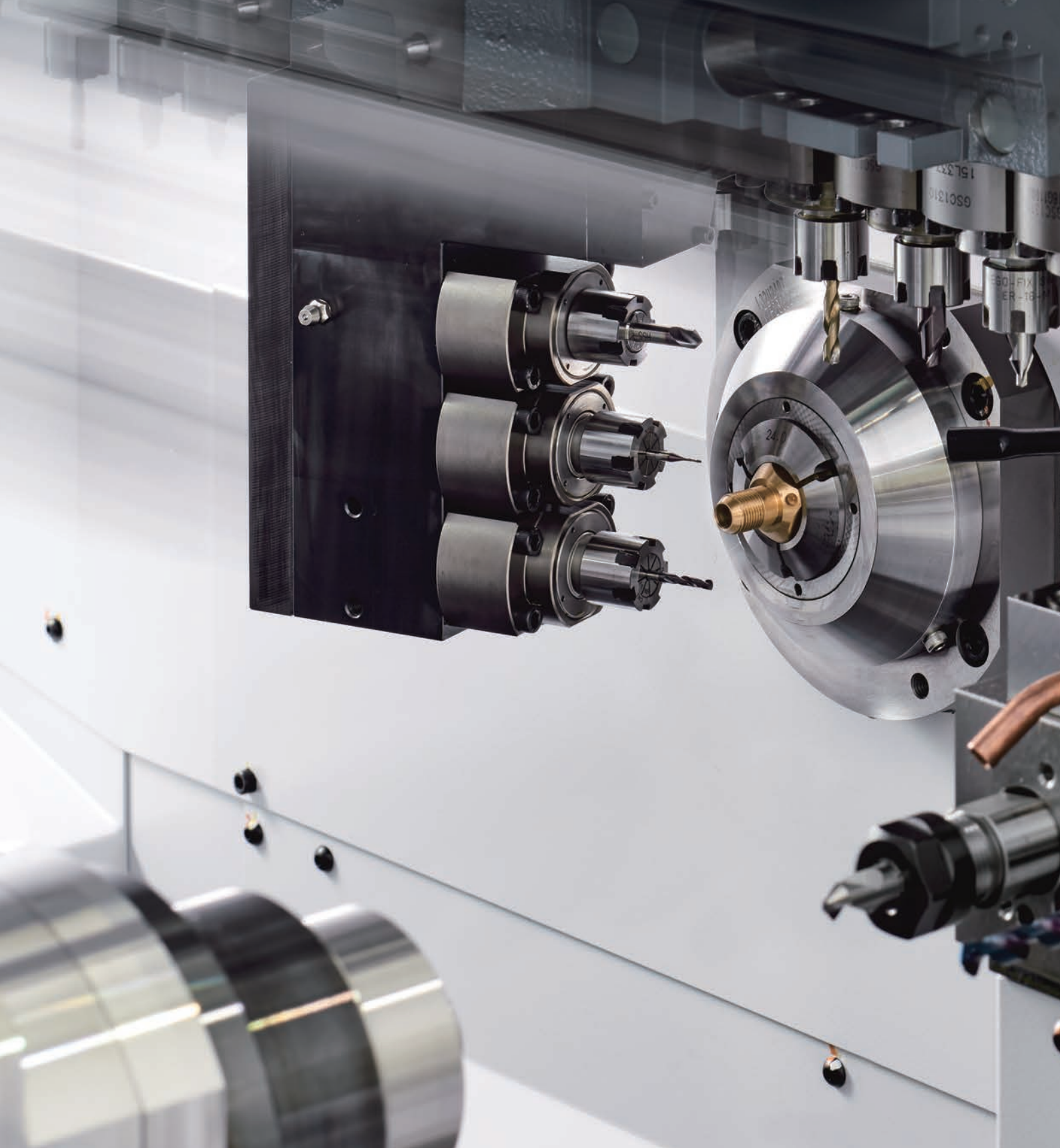

## Cincom's Time-tested L Series Adopts Modular Design

A best-selling machine with a legacy at Cincom, the L32, has seen the launch of 4 new models with a modular design. Ranging from a 7-axis machine with excellent cost performance to a high-end machine equipped with B axis and back tool post Y axis, you can select the machine according to the functions you require.

A wide range of modular tooling ensures that the new L32 is both versatile and flexible to meet your production demands into the future.



**LfV function is now available on all axes**



L32 VIII



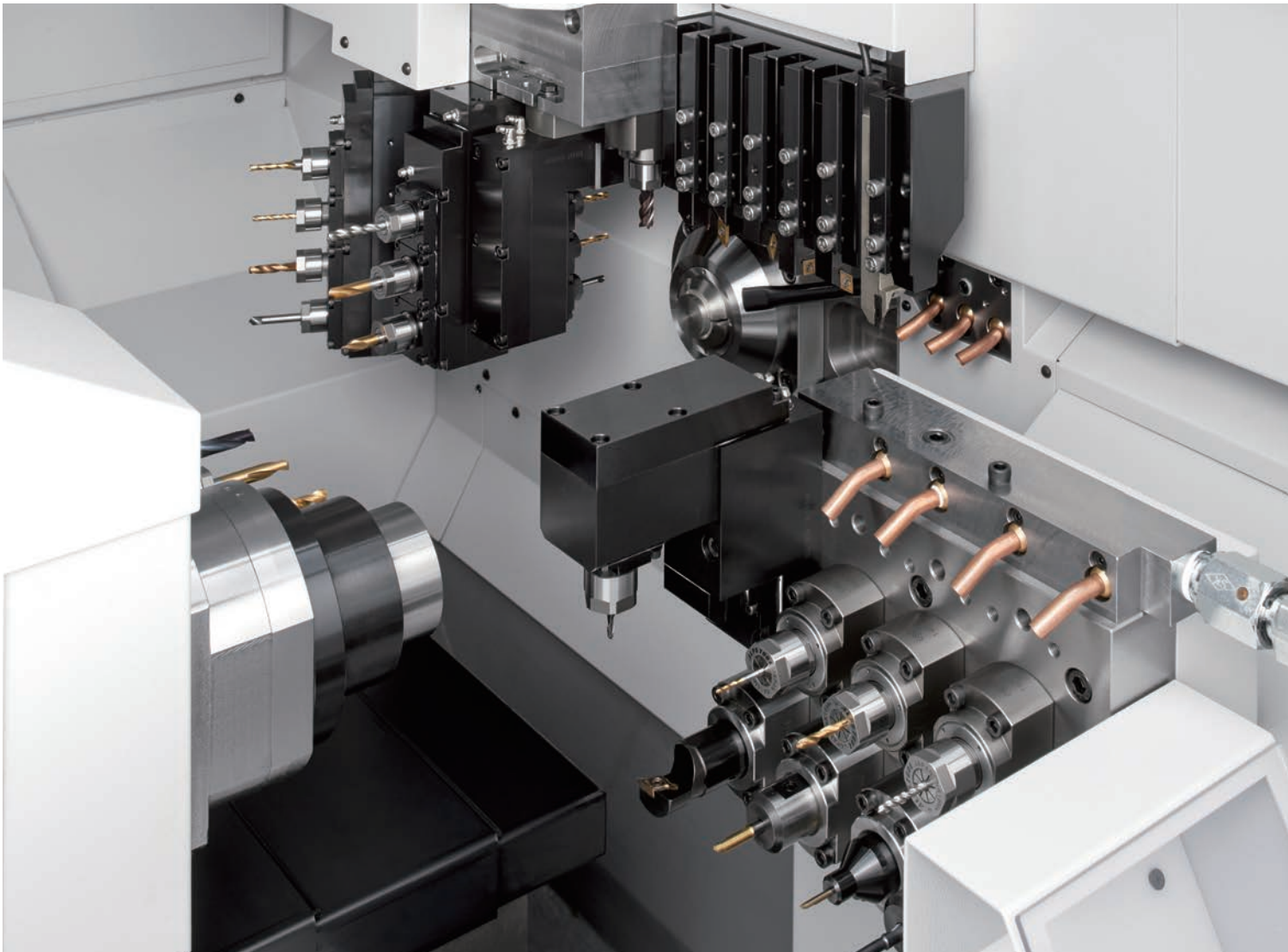

L32 XII

## Basic Construction

Type	VIII	IX	X	XII
B axis (rotary tools on the gang tool post)	N/A	Std.	N/A	Std.
Y2 axis (rear tool post Y axis)	N/A	N/A	Std.	Std.
Rotary tools on the opposite tool post	OP	OP	OP	OP
Rotary tools on the rear tool post	OP	OP	Std.	Std.

Rear tool post rotary tools Optional for Type VIII/IX  
 6,000 min-1 (Max.)  
 3,000 min-1 (rating)  
 Motor : 1.0 kW

Front spindle  
 8,000 min-1  
 C axis 0.001 (DEGREE SYMBOL) as standard  
 Motor : 3.7/ 7.5kW  
 Max. machining length : 320 mm/ 1chucking (GB)

Rotary tools on the gang tool post  
 6,000 min-1 (Max.)  
 4,500 min-1 (rating)  
 Motor : 1.0 kW

Rotary tools on the opposite tool post \*optional  
 6,000 min-1 (Max.)  
 3,000 min-1 (rating)  
 Motor : 1.0 kW

Sub spindle  
 8,000 min-1  
 C axis 0.001 (DEGREE SYMBOL) as standard  
 Motor : 2.2/ 3.7 kW

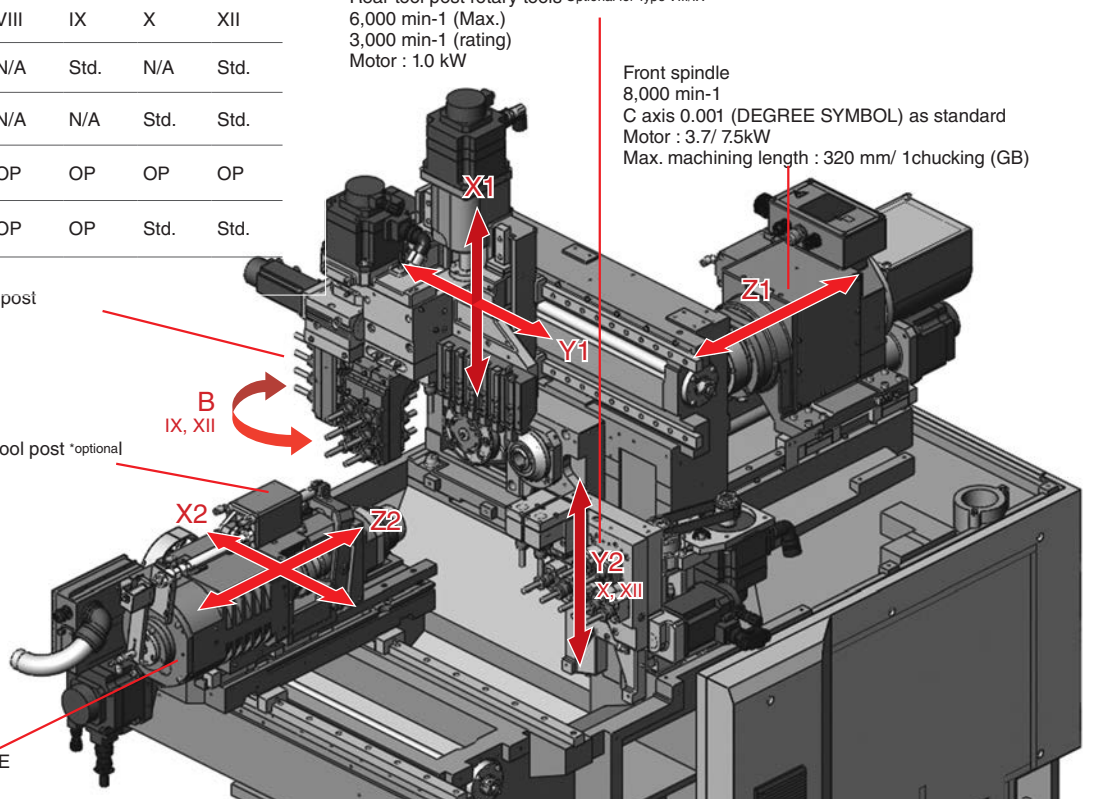

# Function modules that can be combined without restrictions

With a modular design, the L32 has a lineup of four Types – VIII, IX, X and XII – which can be combined with selected variations: rotary tools on a gang tool post, an opposite tool post, or a back tool post.

We allow selection of functions according to the machining needs, and help customers optimise their manufacturing by combining these functions to achieve their ideal machine configuration.

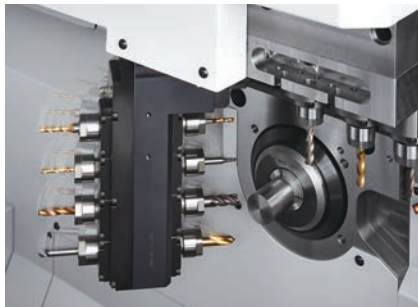

U32B (Rotary tool on the gang tool post B axis)



U121B (Rotary tool on the opposite tool post)



U12B (Rear tool post incorporating Y axis)

## Ability to switch between guide bush and guide bushless operation

The guide bush can be fitted and removed in a quick and simple operation. When machining long thin workpieces, the machine is used as a guide bush type. When producing less than two and half times diameter components, it can be used in guide bushless mode. The benefits are shorter bar remnants and ability to use bar stock with variable diameter tolerance.

## Optional 38 mm diameter bar capacity

There is an option to increase to 38 mm diameter spindle capacity. The maximum machining length per chucking is the same as the standard specifications at 320 mm.

## Workpiece conveyor equipped as standard

A workpiece conveyor is equipped as standard to facilitate the efficient unloading of high volume parts production.



Guide bushless type



Guide bush type



## The LFBV function available as an option for effective machining of difficult-to-cut material (optional)



LFBV (low-frequency vibration cutting) is a technology for performing machining whilst oscillating the X and Z servo axes in the cutting direction in synchronisation with the rotation of the spindle. It reduces all problems caused by swarf entangling with the component or tool, and is effective for small-diameter deep hole machining and the machining of difficult to chip materials.

### Vibration mode

Item	LFBV mode 1	LFBV mode 2
Operation	Multiple vibrations per spindle revolution	Multiple spindle revolutions per vibration
Specification	The axes execute multiple vibrations during one spindle revolution, reliably breaking chips up into small pieces.	Machining is carried out while rotating the spindle multiple revolutions per vibration
Application	Ideal for outer/inner diameter machining and groove machining	Ideal for micro-drilling, where peripheral speed is required
Waveform		

\*LFBV is a registered trademark of Citizen Watch Co., Ltd.

### Comparison of chips

Material: SUS304 Weight: 14.3 g (same scale)



Swarf generated by customary cutting



Chips generated by cutting using LFBV

Model	Front side LFBV	Back side LFBV	LFBV mode 1	LFBV mode 2	LFBV mode 3
VII			✓	✓	✓
IX	X1, Z1	X3, Z3	✓	✓	✓
X			✓	✓	✓
XII			✓	✓	✓

# Intuitive screen display is readable at a glance



## Equipped with high-speed NC

The machine is equipped with the latest NC model to drastically reduce the start-up and screen switching time compared to conventional machines with advanced functions.

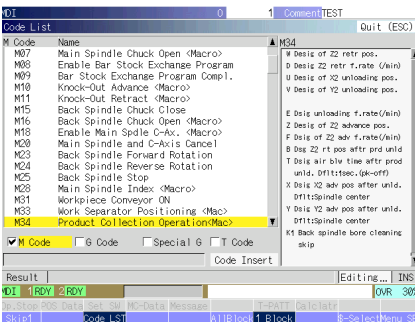

## Display of code list

The function displays the list of G and M codes including explanations to aid programming.



## On-machine program check function

Using manual handle feed, operations can be run in the forward or reverse directions, and you can temporarily stop program operation, edit the program, and then restart operation.

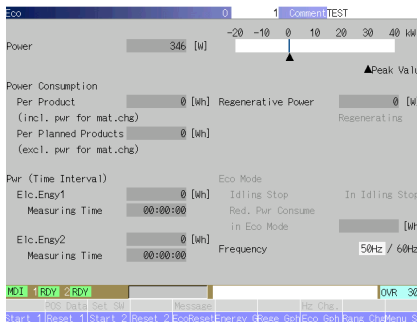

## Eco screen

The current power consumption is shown on the screen, along with the cumulative power consumption, and the power regeneration (generation) status.

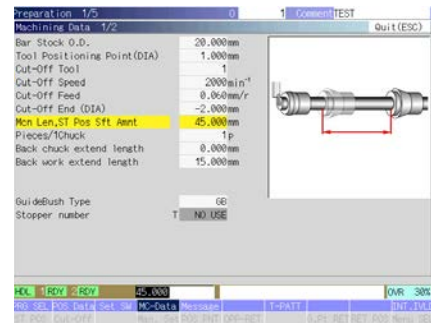

## Display of easily understood illustrations

Illustrations appropriate for each item are displayed. You can see what they mean at a glance (the screen shown above displays the machining data).

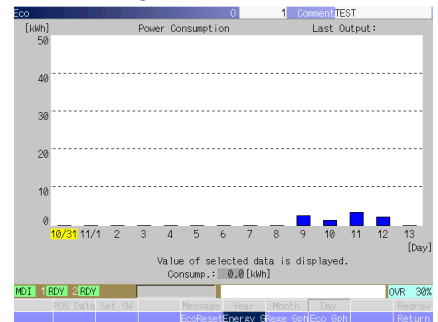

## Eco screen (example graph display)

The machine's power consumption can also be shown in the form of an easy-to-understand graph.

# The next process starts before the current one ends

## Multiple tool post overlapping function

Independent opposite and gang tool posts are provided. In front machining, idle time has been completely eliminated by using a unique control method. The next tool post to be used starts preparation for machining without waiting for the other one to complete its retraction operation.

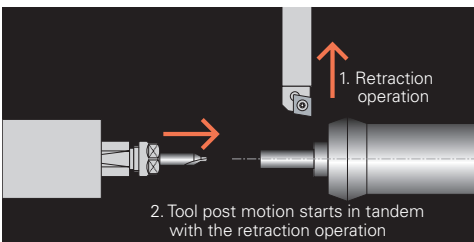

## Direct spindle indexing function

This substantially reduces spindle indexing time. When indexing the spindle, this function allows the spindle to be decelerated and stopped at the required index position by specifying this position with a C-axis command while the spindle is rotating. This eliminates the idle time up until rotation stops, and improves working efficiency.

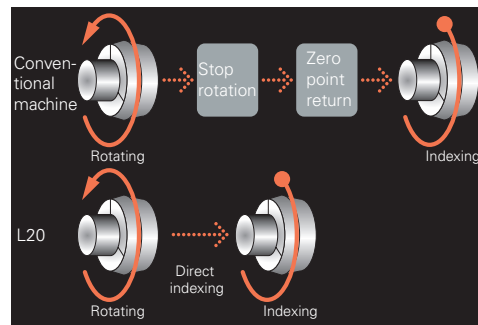

## External view

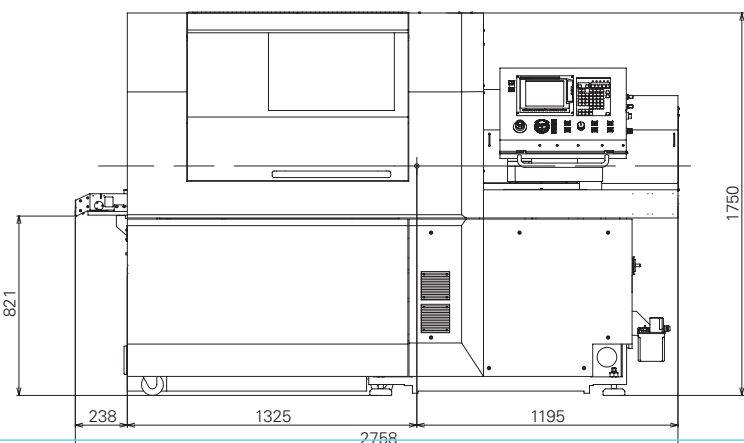
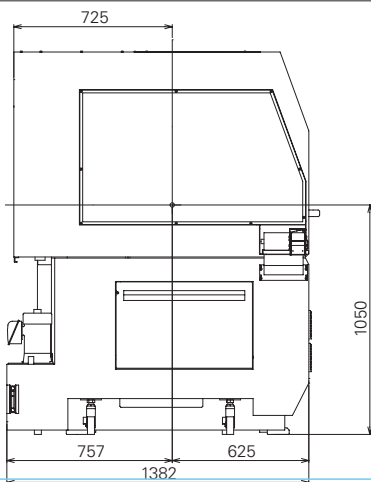

# Tooling area

VIII  
IX

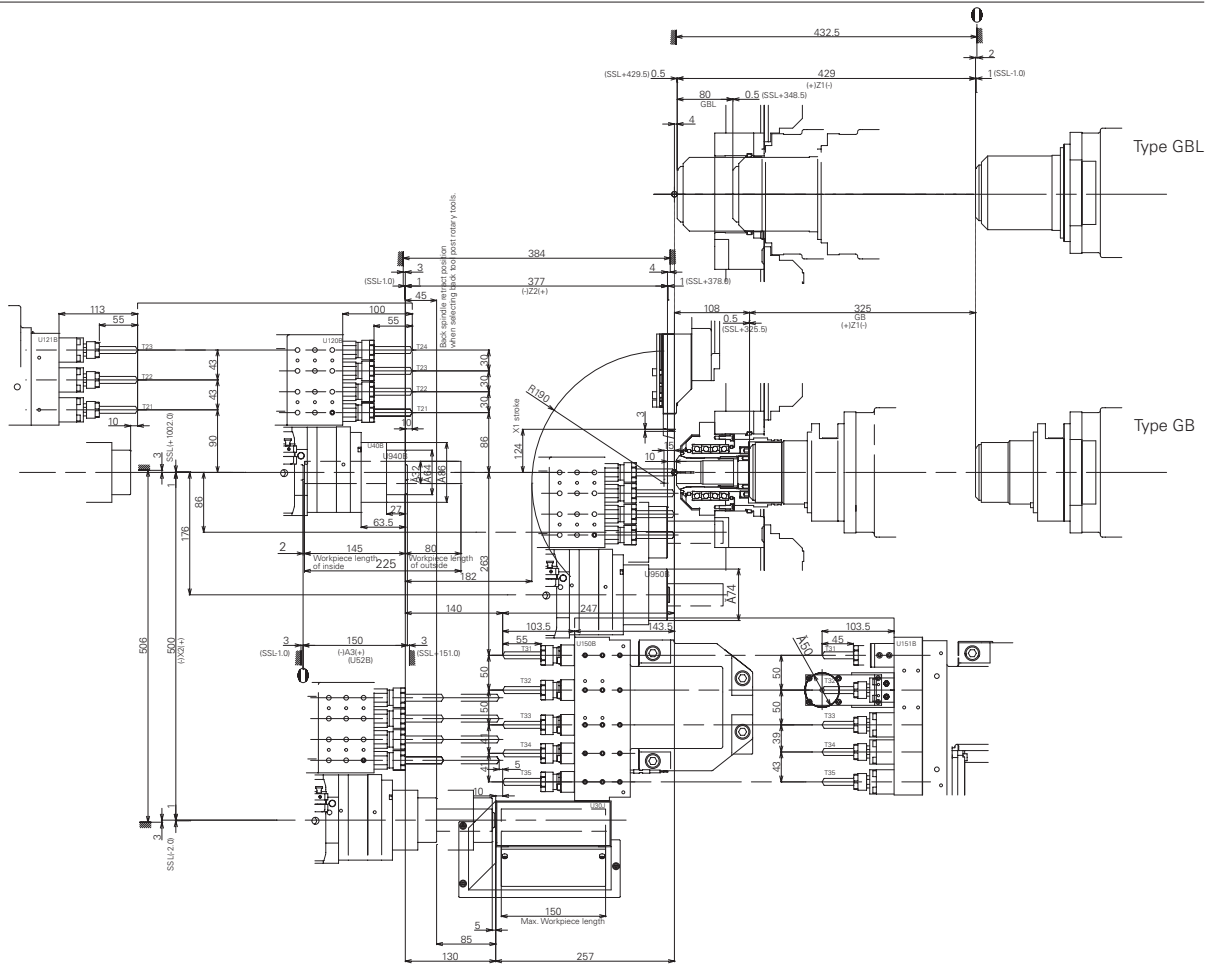

X  
XII

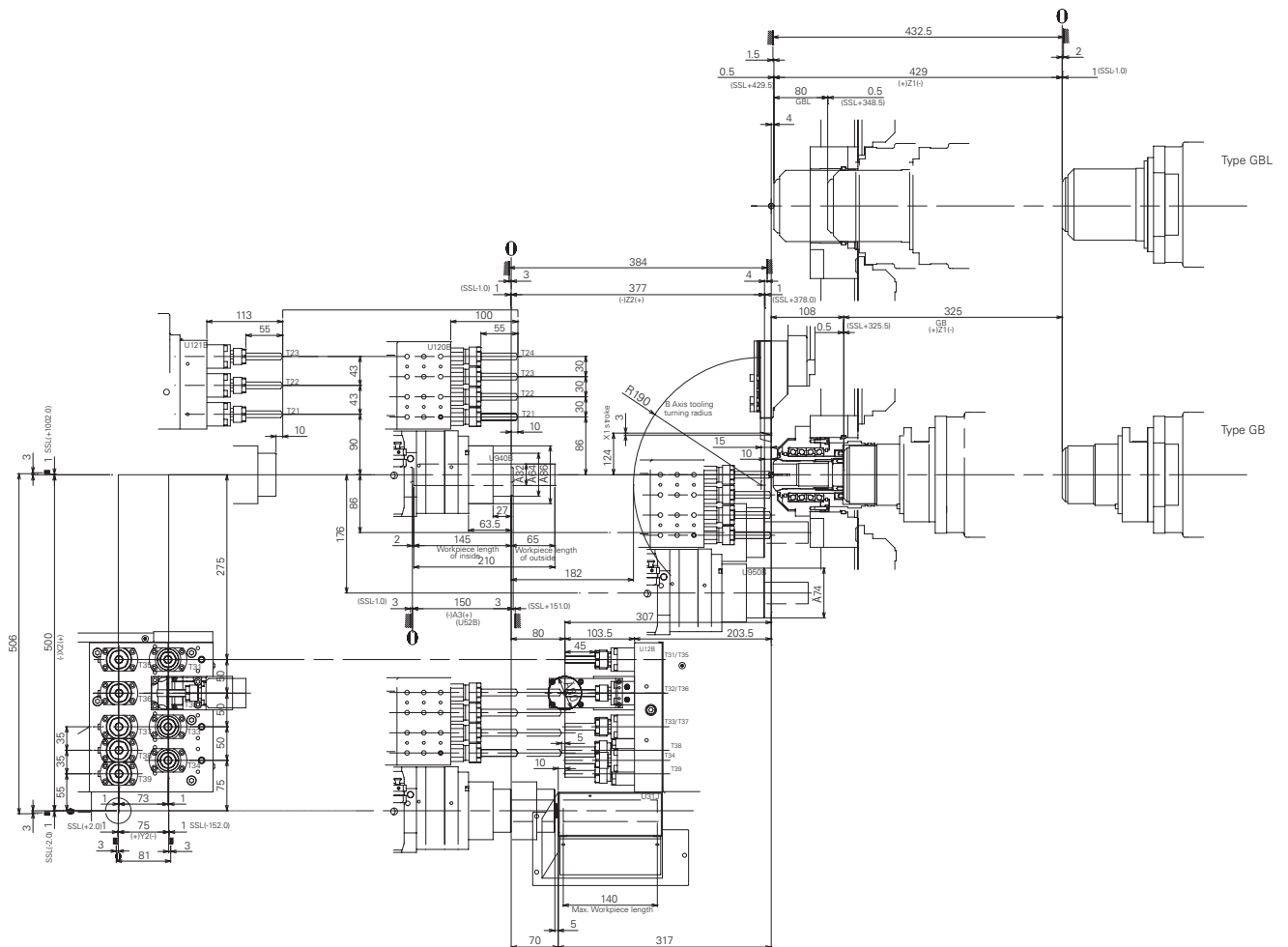

# Machine Specification

Item	L32			
	VIII	IX	X	XII
	L32 - 1M8 L32 - 1M9 L32 - 1M10 L32 - 1M12			
Max. machining diameter (D)	32 mm Dia. (38 mm Dia. Option)			
Max. machining length (L)	GB: 320 mm/ 1chucking, GBL: 2.5D			
Max. front drilling diameter	12 mm Dia.			
Max. front tapping diameter	M12			
Spindle through-hole diameter	39 mm Dia.			
Main spindle speed	Max. 8,000 min-1			
Max. chuck diameter of the back spindle	32 mm Dia.			
Max. protrusion length of the back spindle workpiece	80 mm	65 mm		
Max. protrusion length	150 mm	140 mm		
Max. drilling diameter for the back spindle	10 mm Dia.			
Max. tapping diameter for the back spindle	M10			
Back spindle speed	Max. 8,000 min-1			
Gang rotary tool				
Max. drilling diameter	10 mm Dia.			
Max. tapping diameter	M8			
Spindle speed	Max. 6,000 min-1 Rating: 4,500min-1			
Back tool post rotary tool *1				
Max. drilling diameter	8 mm Dia.			
Max. tapping diameter	M6			
Spindle speed	Max. 6,000 min-1 Rating: 3,000 min-1			
Front rotary tool *2				
Max. drilling diameter	8 mm Dia.			
Max. tapping diameter	M6			
Spindle speed	Max. 6,000 min-1 (Rating: 3,000 min-1)			
Number of tools to be mounted max	19 - 30	26 - 36	24 - 44	30 - 40
Gang turning tool	6	6	6	6
Gang rotary tool	4 - 6	7 - 11	5 - 13	7 - 11
Front drilling tool	4 - 9	4 - 14	4 - 16	4 - 9
Back drilling tool	5 - 11	9 - 15	9 - 20	13 - 19
Tool size				
Gang turning tool	16 mm SQ×130 mm			
Sleeve	25.4 mm Dia.			
Chuck and bushing				
Main spindle collet chuck	FC081-M (FC251-M: 38 mm Dia. spec.)			
Back spindle collet chuck	FC081-M (FC251-M: 38 mm Dia. spec.)			
Rotary tool collet chuck	ER11, ER16			
Chuck for drill sleeves	ER11, ER16			
Guide bushing	FG531-M (FG581-M: 38 mm Dia. spec.)			
Rapid feed rate				
All axes (except Y2)	32 m/ min			
Y2 axis	---		24 m/ min	
Motors				
Spindle drive	3.7/ 7.5 kW			
Gang tool post rotary tool drive	1.0 kW			
Back spindle drive	2.2/ 3.7 kW			
Back tool post rotary tool drive *1	1.0 kW			
Front rotary tool drive *2	1.0 kW			
Coolant oil	0.4 kW			
Lubricating oil	0.003 kW			
Centre height	1,050 mm			
Rated power consumption	13.2 KVA			
Full-load current	36 A			
Main breaker capacity	60 A			
Air pressure and air flow rate for pneumatic devices	0.5 MPa 64.2 NL/ min			
Weight	2,850 kg		2,900 kg	

## Standard accessories

Main spindle chucking unit	Back spindle chucking unit
Gang rotary tool driving unit	Coolant unit (with level detector)
Lubricating oil supply unit (with level detector)	Machine relocation detector
Door lock	Cut-off tool breakage detector
Work conveyer	Lighting
Rotary guide bushing drive unit	Main spindle coolant unit
Back tool post rotary unit <sup>*type X,XII</sup>	Automatic fire extinguisher

## Special accessories

Rotary guide bushing unit	Knock-out jig for through-hole workpiece
Chip conveyor	Medium-pressure coolant unit
Coolant flow rate detector	Back rotary tool unit <sup>*type VIII,IX</sup>
Signal lamp	3-colour signal tower
Back tool post rotary tool drive device	

## Standard NC functions

CINCOM SYSTEM M70LPC-VU (Mitsubishi)	8.4 inch colour LCD
USB slot	Program storage capacity: 40m (approx. 16KB)
Tool offset pairs: 40	Product counter indication (up to 8 digits)
Operating time display function	Machine operation information display
B axis control function <sup>*type IX,XII</sup>	Back spindle chasing function
Synch tapping phasing function	Interference check function
Spindle speed change detector	Spindle speed change detector
Automatic power-off function	Main spindle indexing at 1° intervals
On-machine program check function	Nose radius compensation
Eco indication	

## Special NC functions

Variable lead thread cutting	Arc threading function
Chamfering, corner R	Geometric function
Multiple repetitive cycle for turning	Spindle synchronized function
Spindle C-axis function	Milling interpolation
Back spindle 1° indexing function	Back spindle C-axis function
Canned cycle drilling	Rigid tapping function
High speed Rigid tapping function	Differential speed rotary tool function
Optional block skip (9 sets)	Tool offset pairs: 80
Back machining program skip function	Tool life management I
Tool life management II	Program storage capacity 600m (approx. 240KB)
External memory program driving	Submicron commands
User macros	Helical interpolation function
Slant helical interpolation function	Hob function
Polygon function	Inch command
Sub inch command	Network I/ O function
LFV	

\*1 Type VIII, Type IX back tool post rotary tool is optional \*2 Front rotary tool drive unit is optional

# CITIZEN

**CITIZEN MACHINERY CO., LTD.**

**Japan**

Citizen Machinery Co., Ltd.  
4107-6 Miyata, Miyota-machi, Kitasaku-gun, Nagano-ken,  
389-0206, Japan

Tel: 81-267-32-5901

Fax: 81-267-32-5908

**Europe-UK**

Citizen Machinery UK Ltd  
1 Park Avenue, Bushey, WD23 2DA, UK

Tel: 44-1923-691500

Fax: 44-1923-691599

[www.citizenmachinery.co.uk](http://www.citizenmachinery.co.uk)

All specifications are subject to change without prior notice. This product is an export control item subject to the foreign exchange and foreign trade act. Thus, before exporting this product, or taking it overseas, contact your CITIZEN machine dealer. Please inform your CITIZEN machine dealer in advance of your intention to re-sell, export or relocate this product. For the avoidance of doubt products includes whole or part, replica or copy, technologies and software. In the event of export, proof of approval to export by government or regulatory authority must be evidenced to CITIZEN. You can operate the machines after the confirmation of CITIZEN CITIZEN is a registered trademark of Citizen Holdings Co., Japan